

# Chaotická dynamika

Badatelé: Jan Hošek, GJKT

Jan Prachař, GFMP

Lukáš Nevařil, AGKM

Radim Šojdr, AGKM

Václav Valeš, G tř.Kpt. Jaroše

# Deterministický chaos

- determinismus
- pohybové rovnice
- řešení diferenciálních rovnic
- počítačové simulace

# Zkoumané systémy

1. Dvojité kyvadlo (double pendulum)
2. Nelineární elektrický obvod

# Dvojité kyvadlo

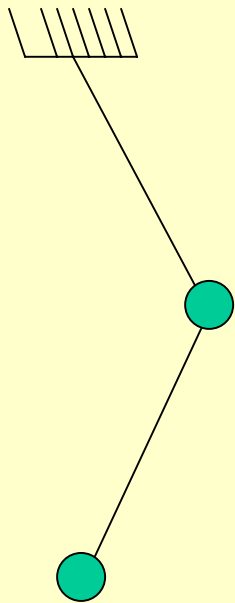

# Poincarého řez

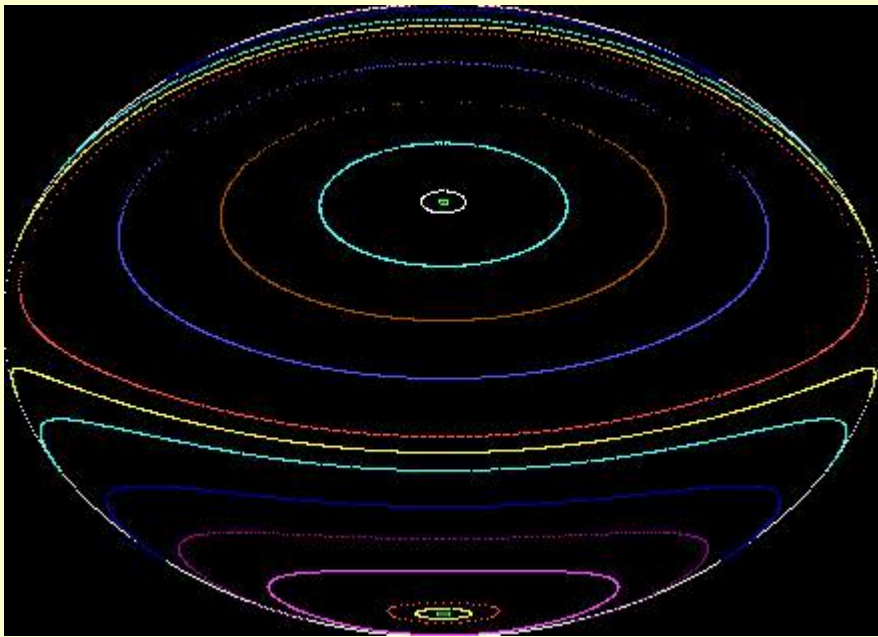

*1 J*

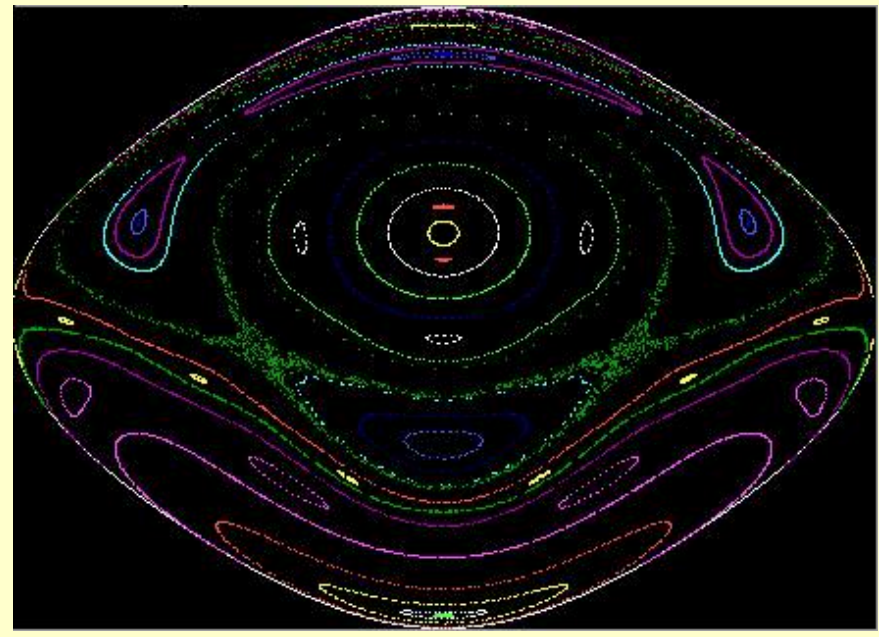

*10 J*

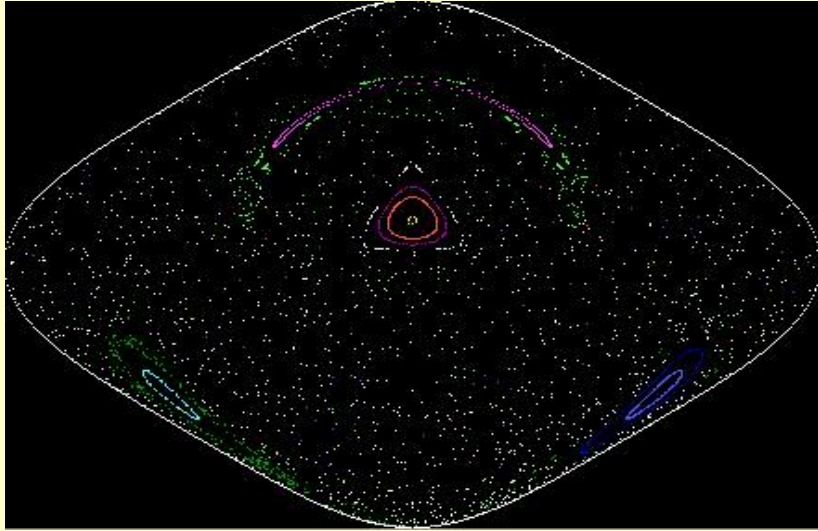

20 J

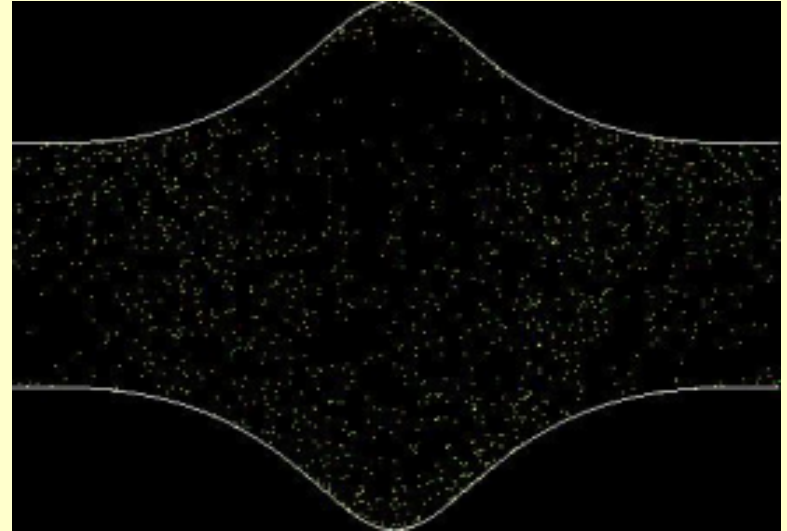

50 J

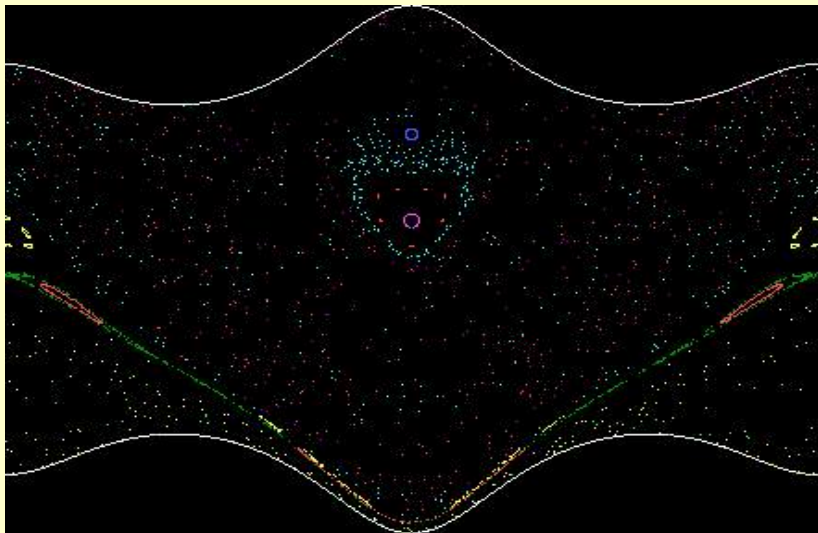

100 J

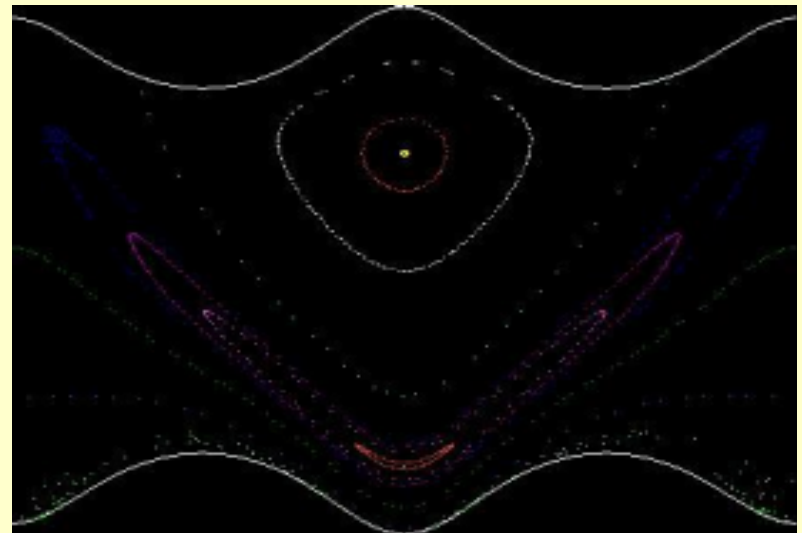

500 J

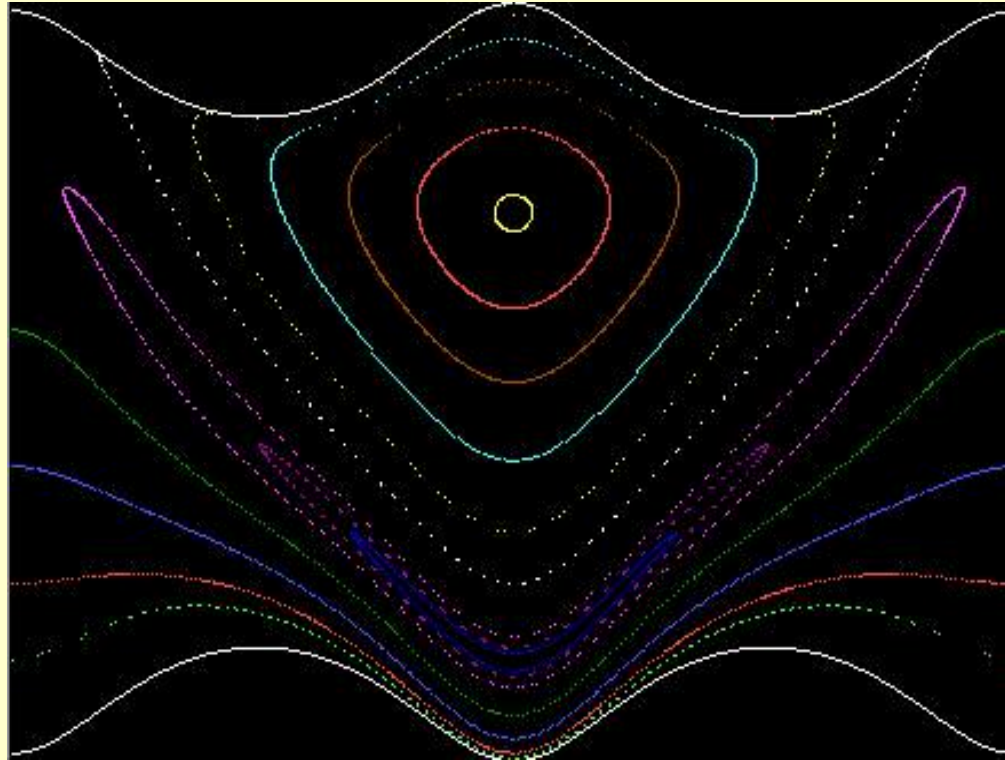

1000 J

# Nelineární elektrický obvod

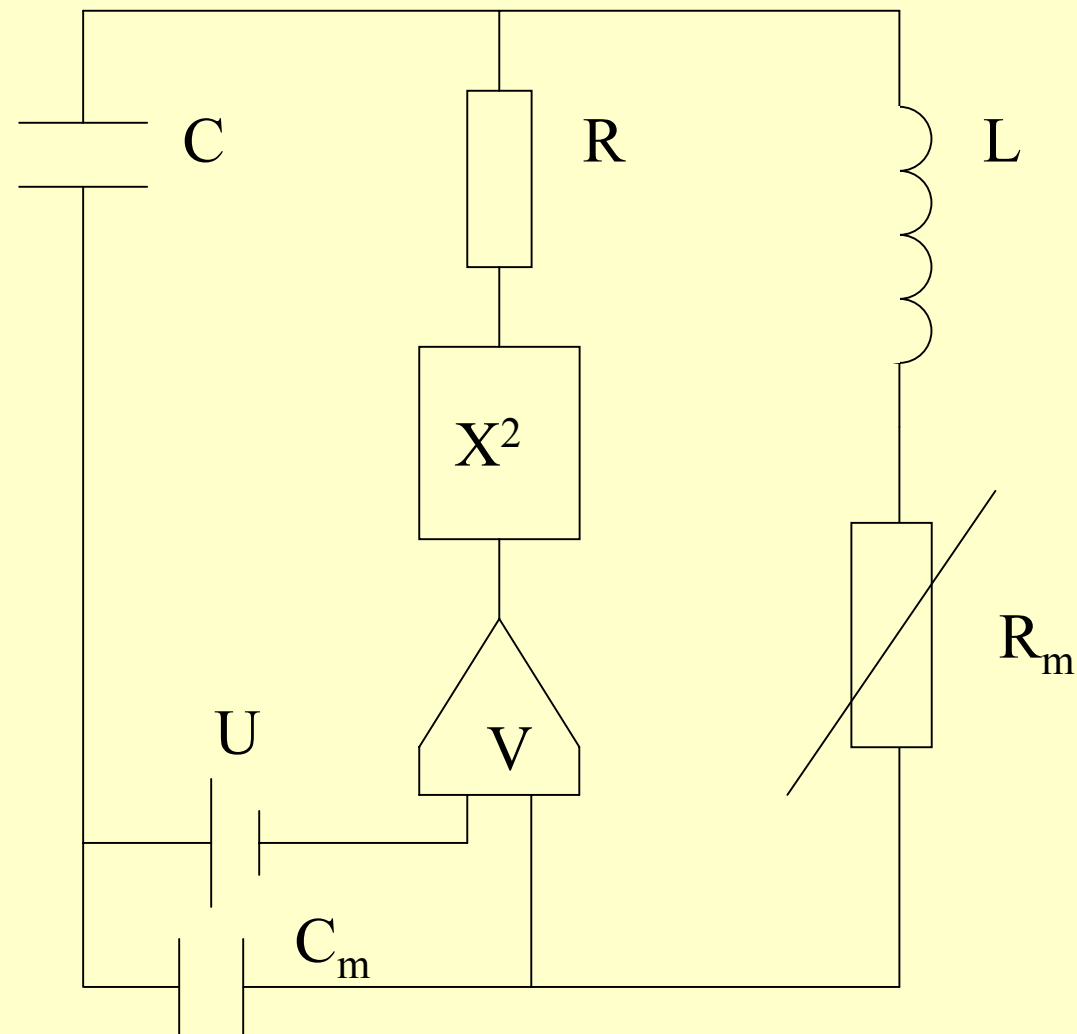



# Bifurkační diagram

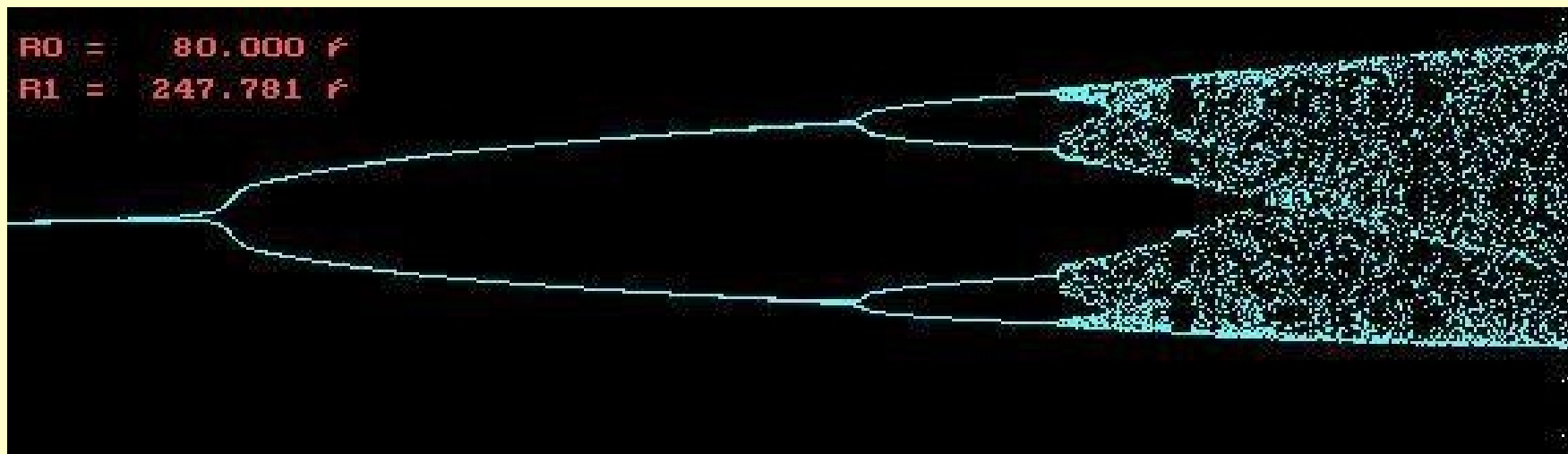

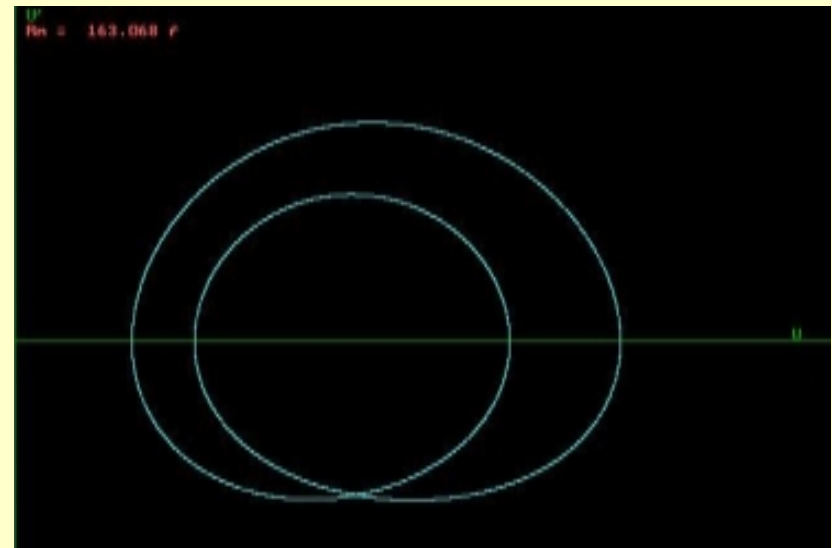
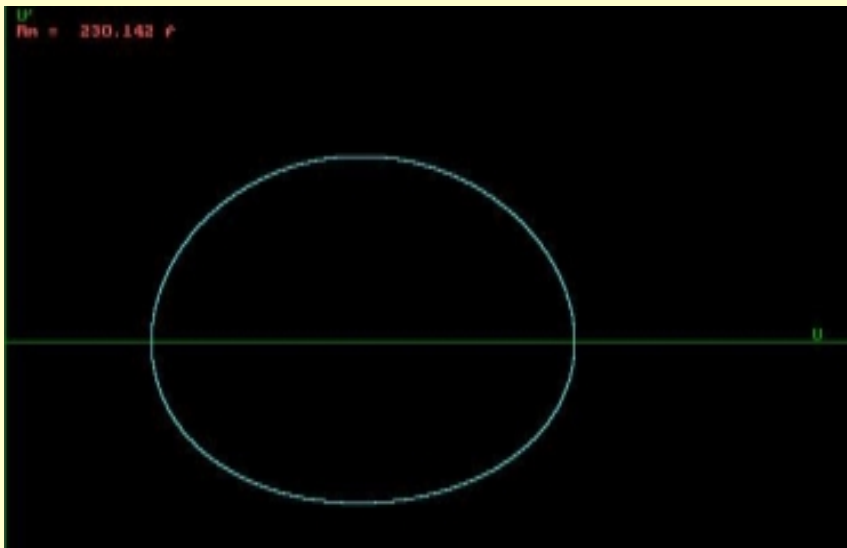
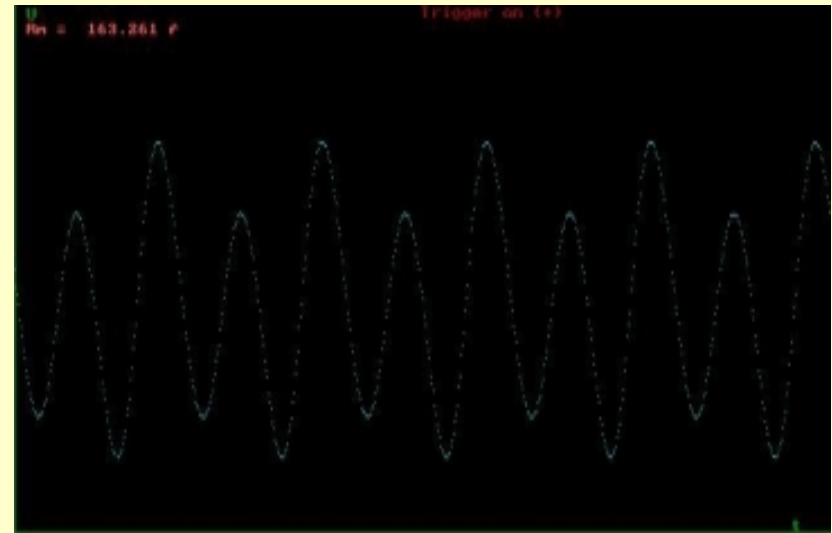
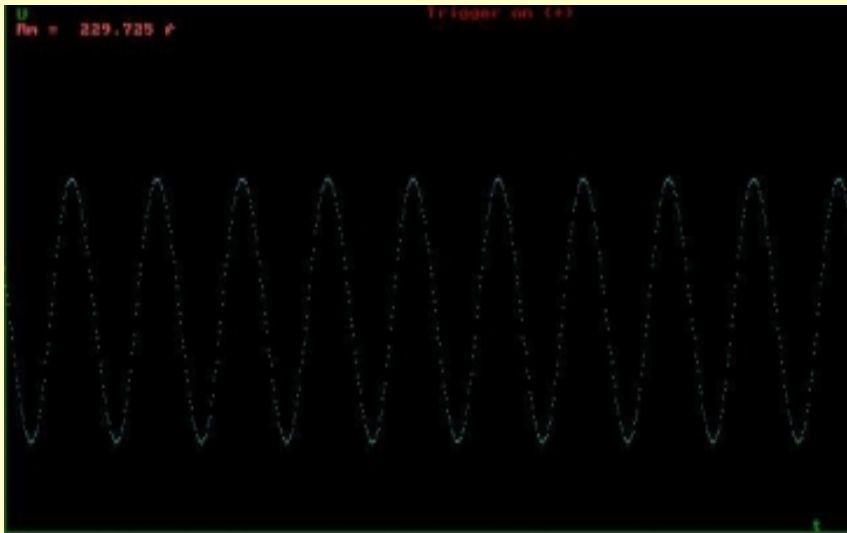

230  $\Omega$

160  $\Omega$

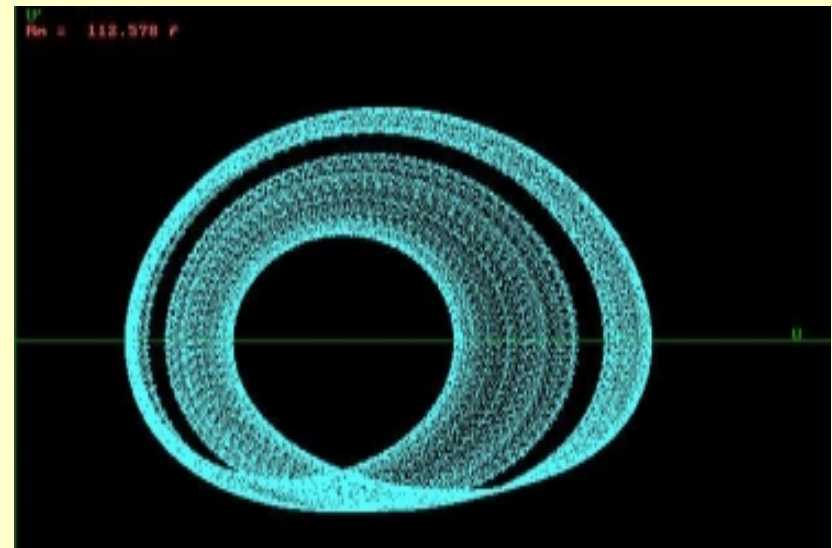
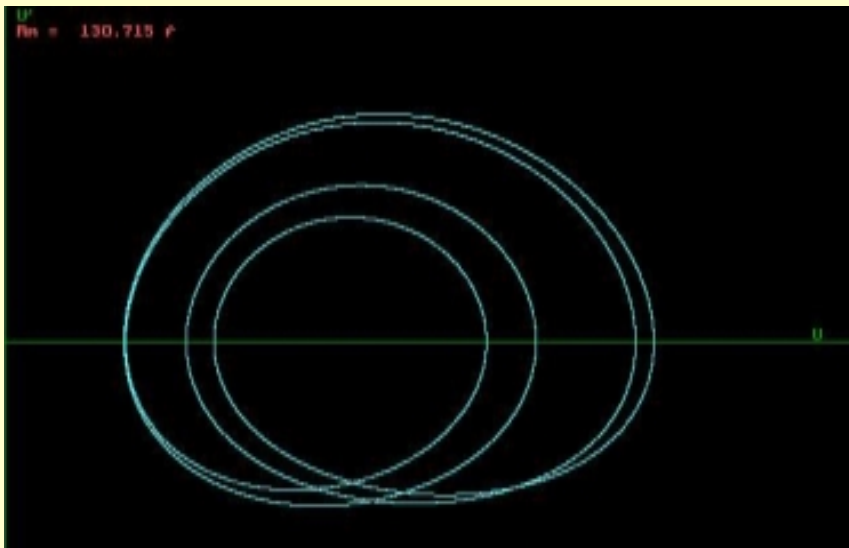
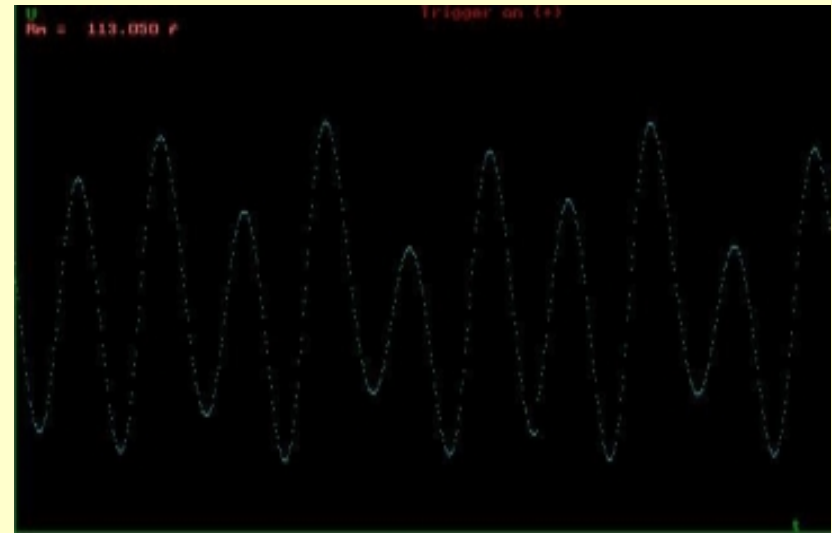
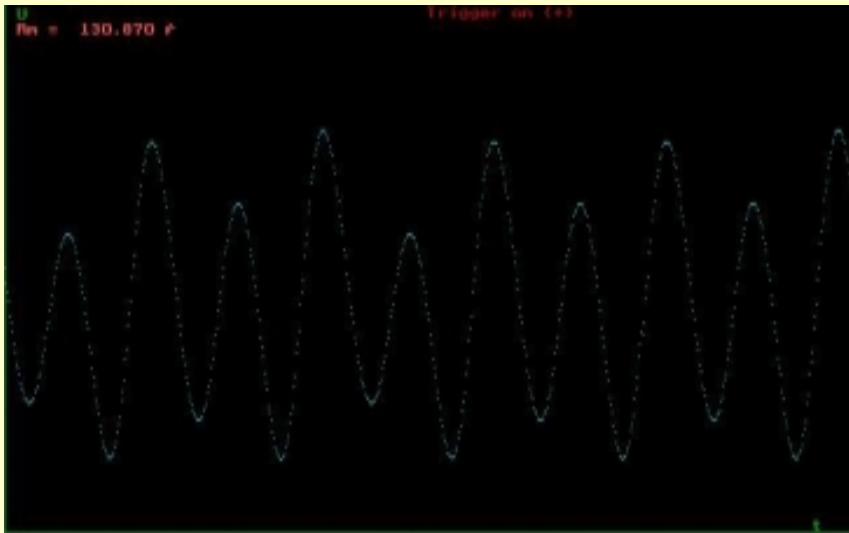

130  $\Omega$

113  $\Omega$

# Závěr

- Určili jsme, pro které počáteční podmínky se systémy chovají chaoticky
- chaotická dynamika přináší důležité poznatky
- všechno je chaos