

Václav Vinkler, Václav Špéra

# Simulace provozu JE typu VVER-440

# Citáty, cíle a motivace

---

# Citáty, cíle a motivace

Percent of Men and Women Who Favor Use of Nuclear Energy: 1983 to 2015

Annual Averages Until 2014

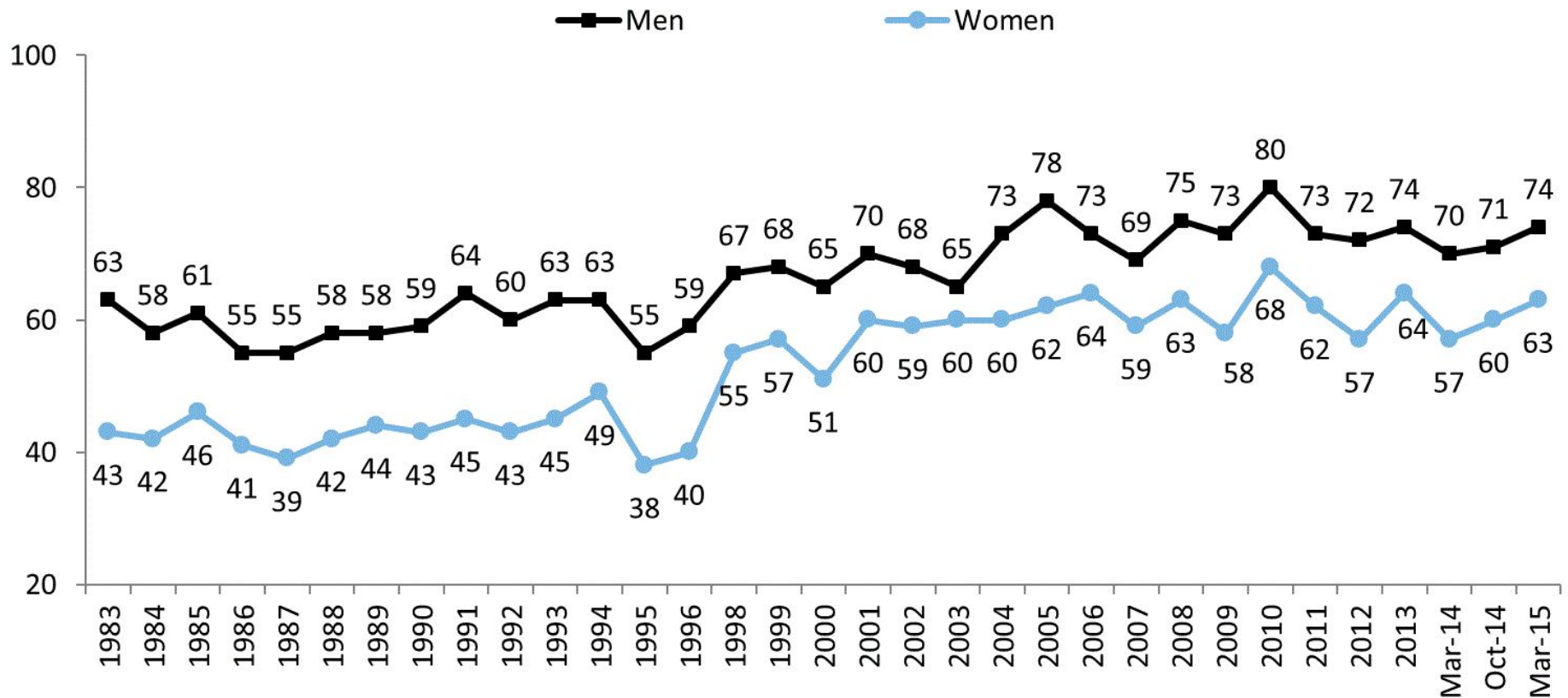

# Citáty, cíle a motivace

What's the most terrifying word in nuclear physics?

Oops!

# Jaderná energie?!

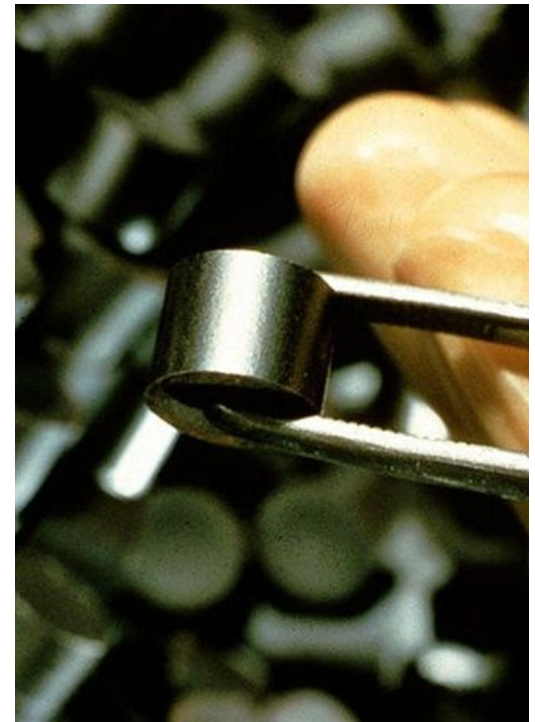

# Rozmanitost inženýrů...

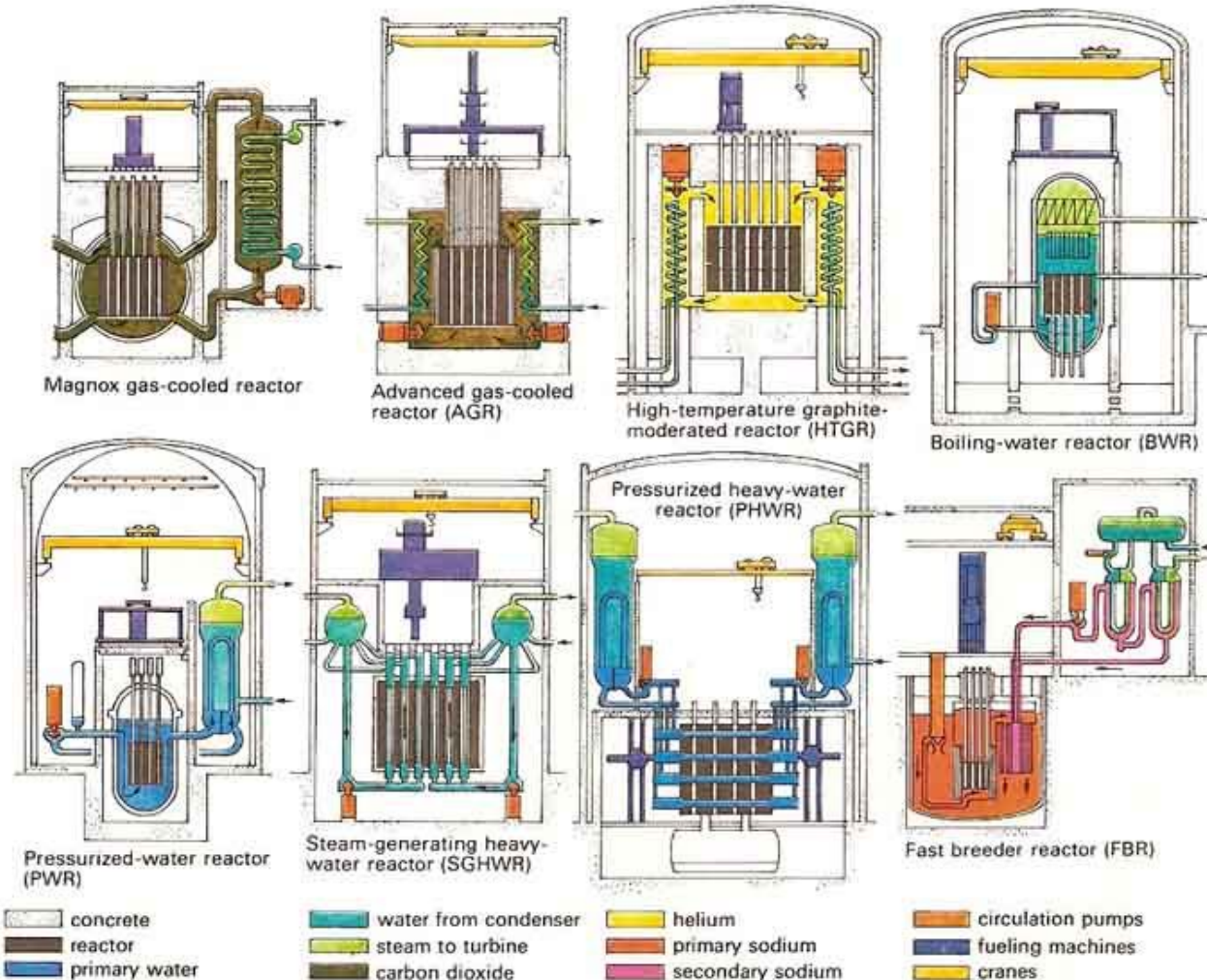

# Schéma JED

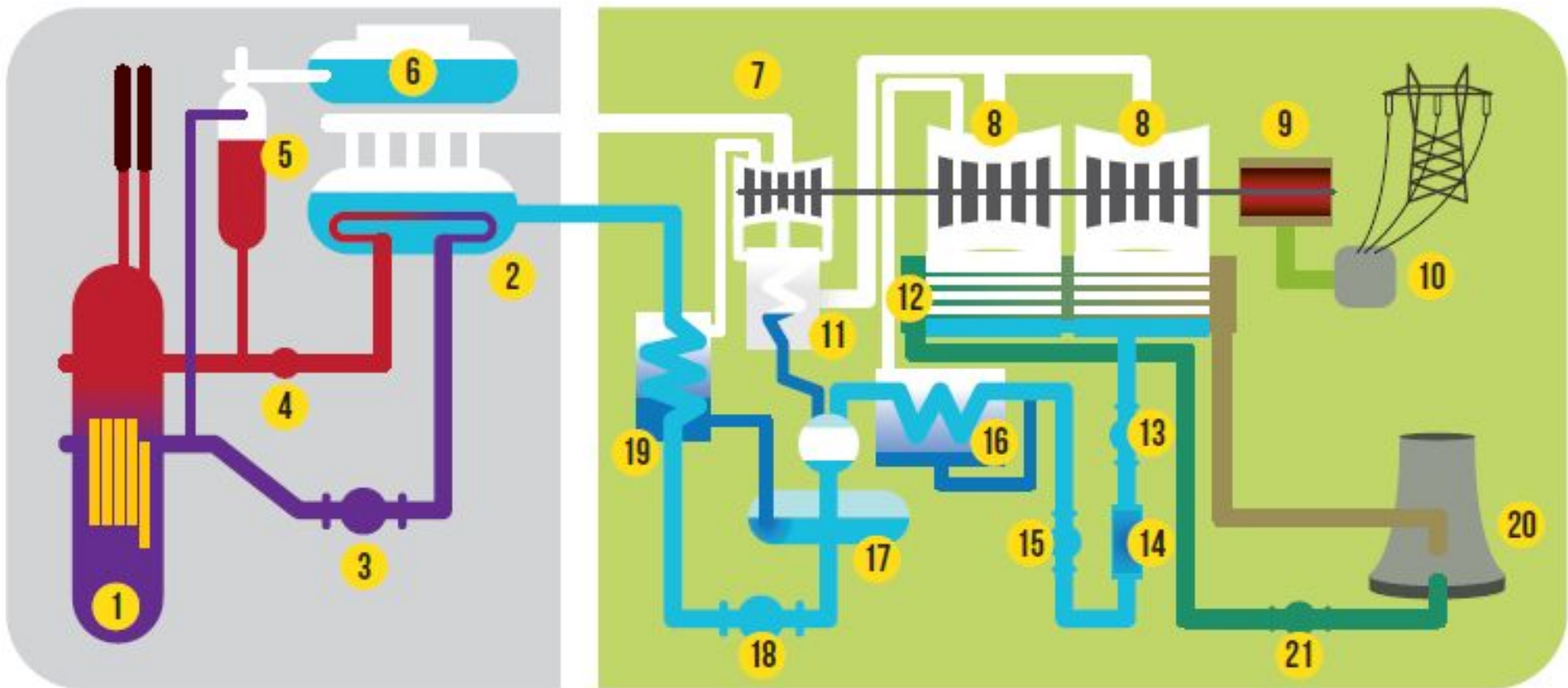



# Řízení elektráren s tlakovodními reaktory

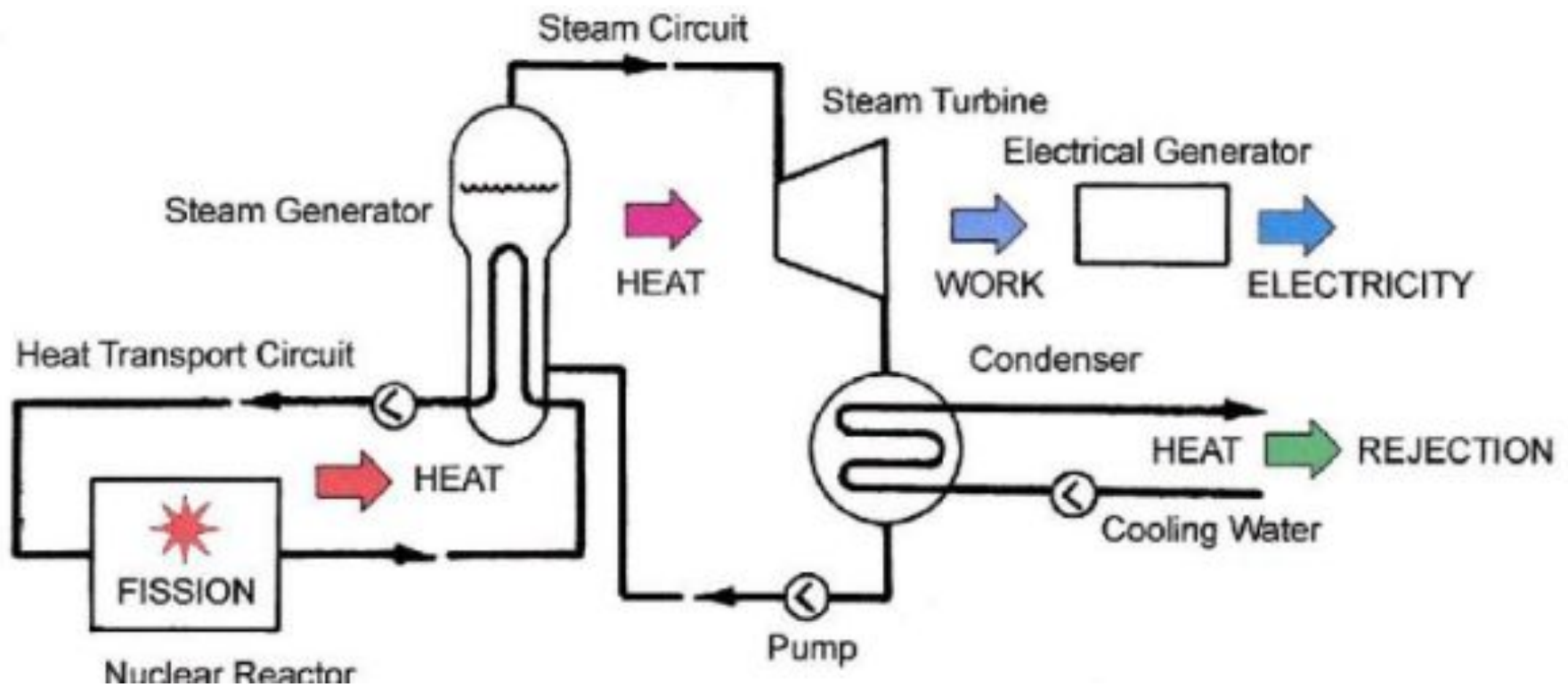



# Faktory výkonu reaktoru



# Změna reaktivity

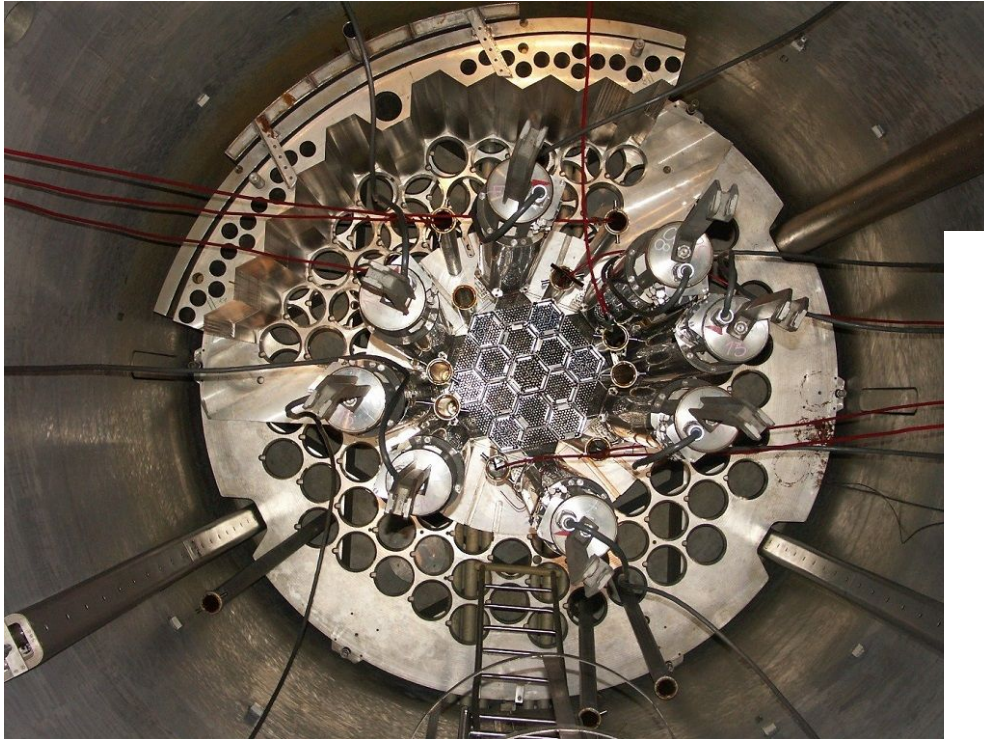

P40E9, P36E9

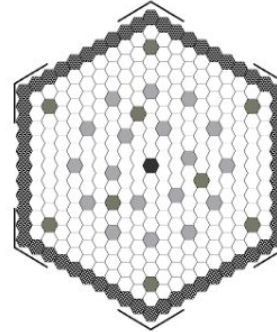

A30E9

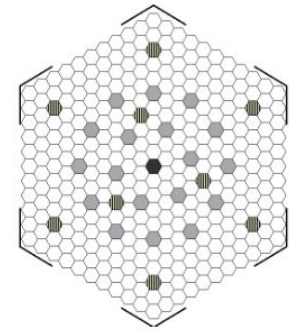

A40E6

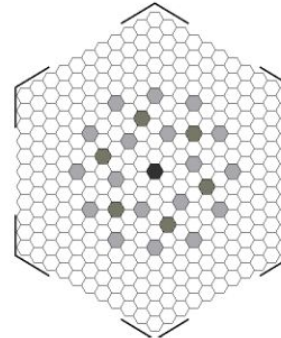

A13, A20

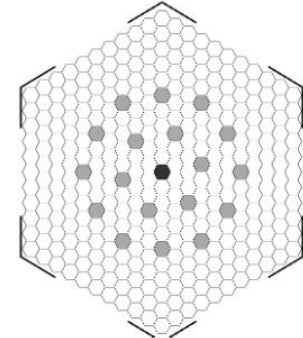

# Záměrné změny





# Samovolné změny

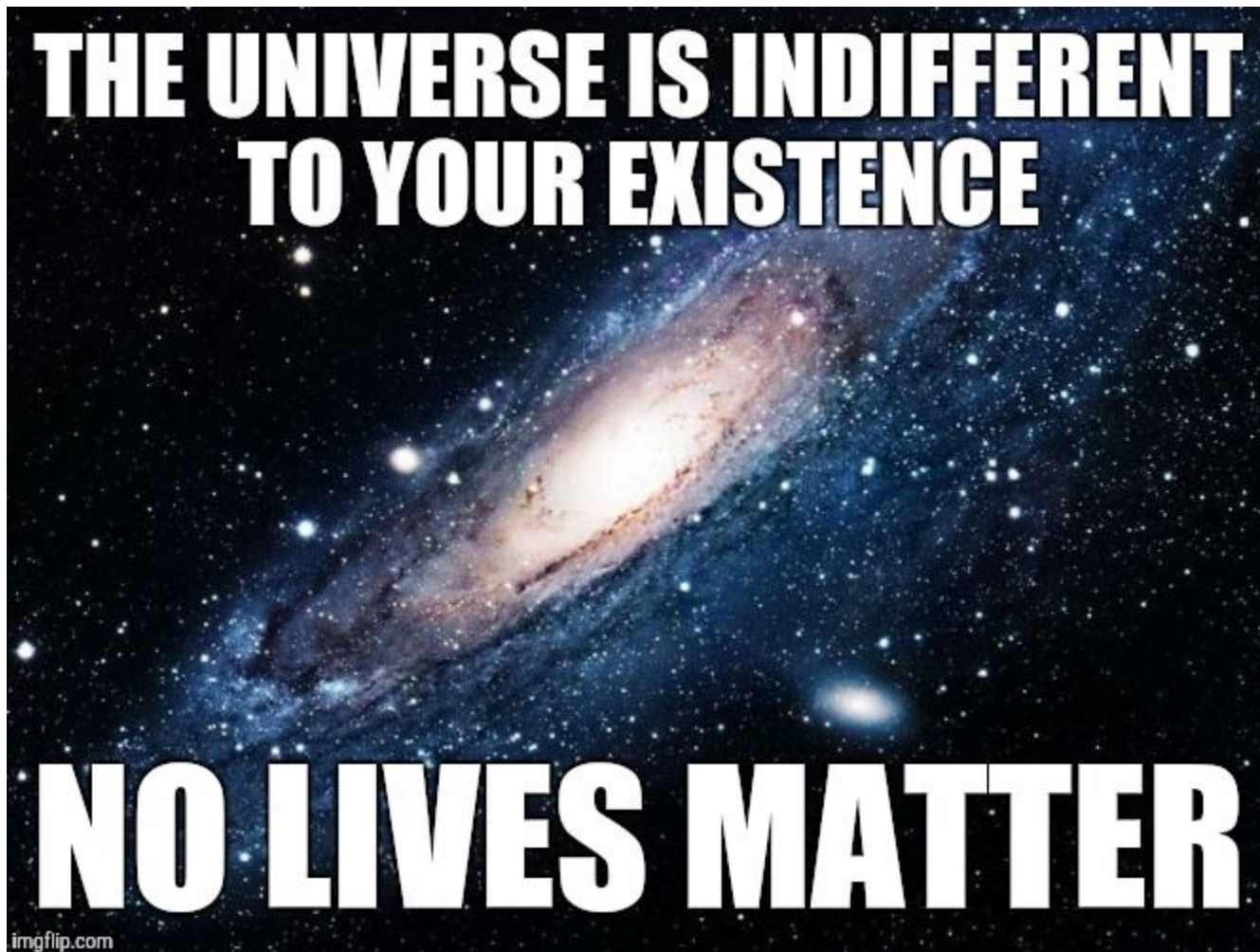

# Simulace



# Výpadek HCČ-2 a HCČ-5

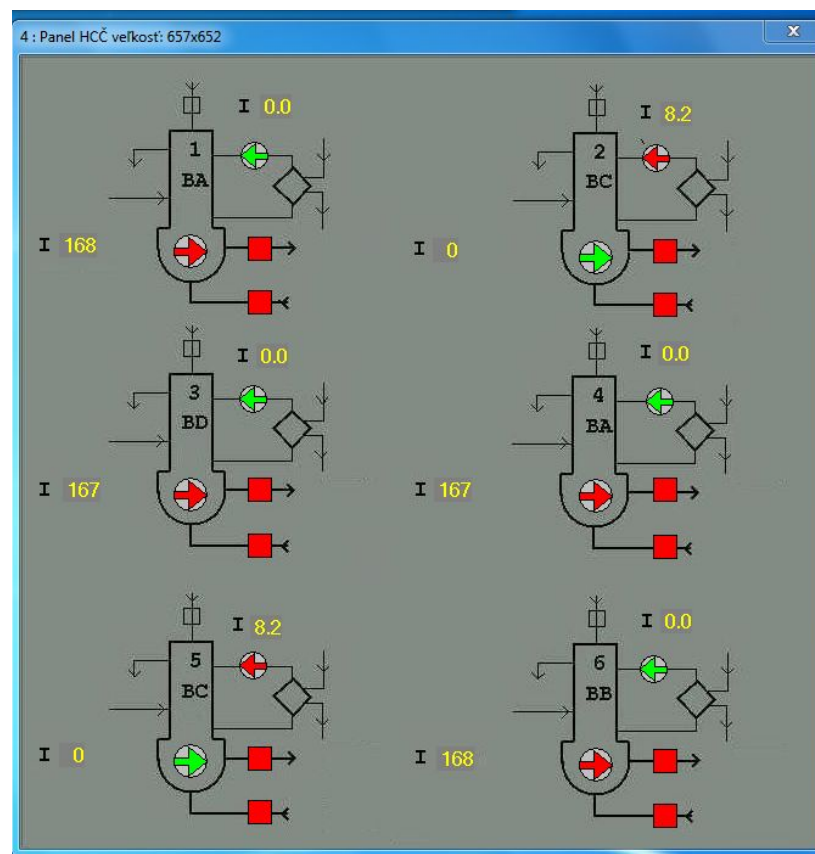
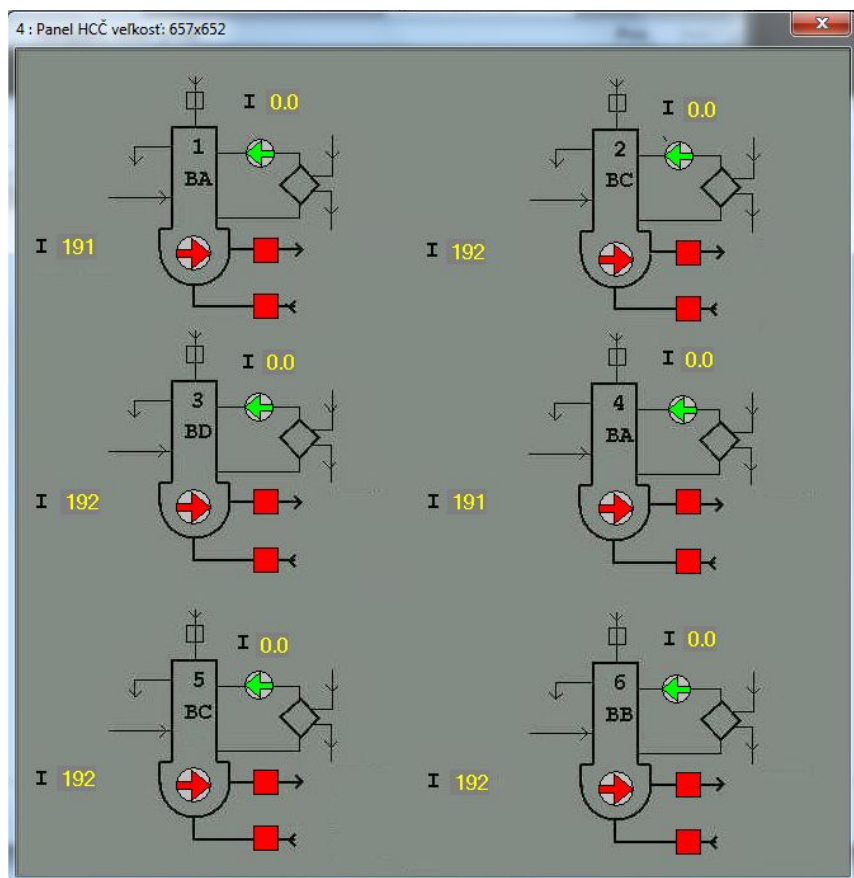

# Výpadek HCČ-2 a HCČ-5

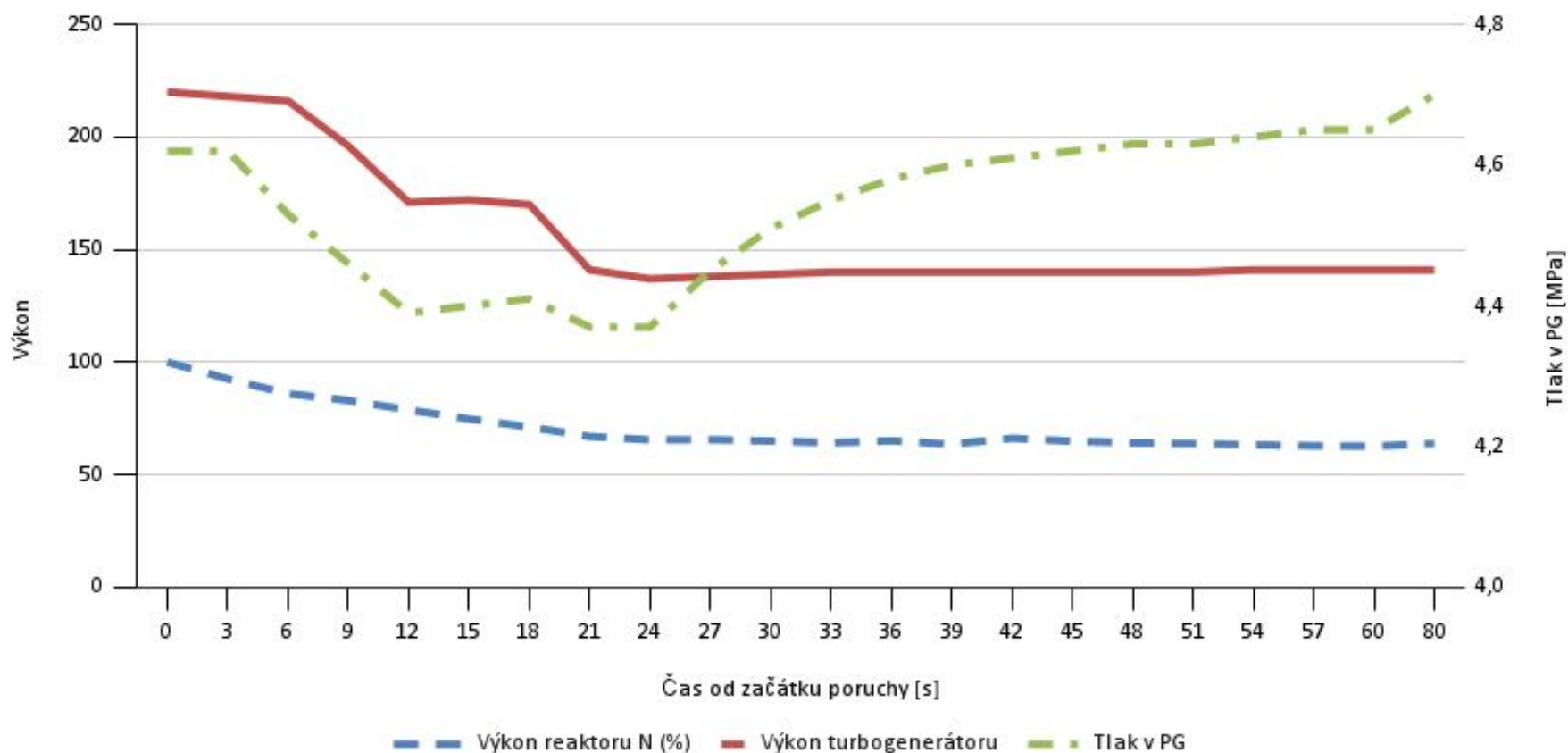



# Výpadek všech HCČ

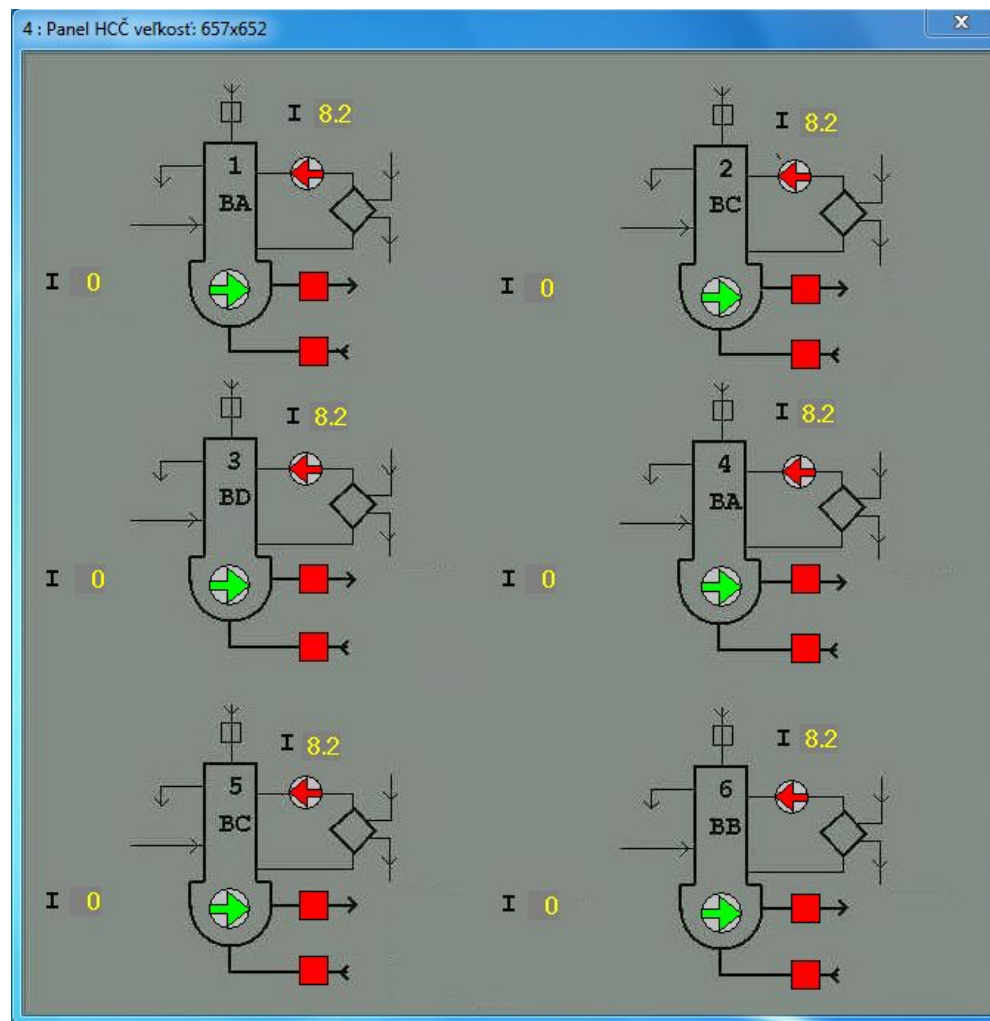

# Výpadek všech HCČ

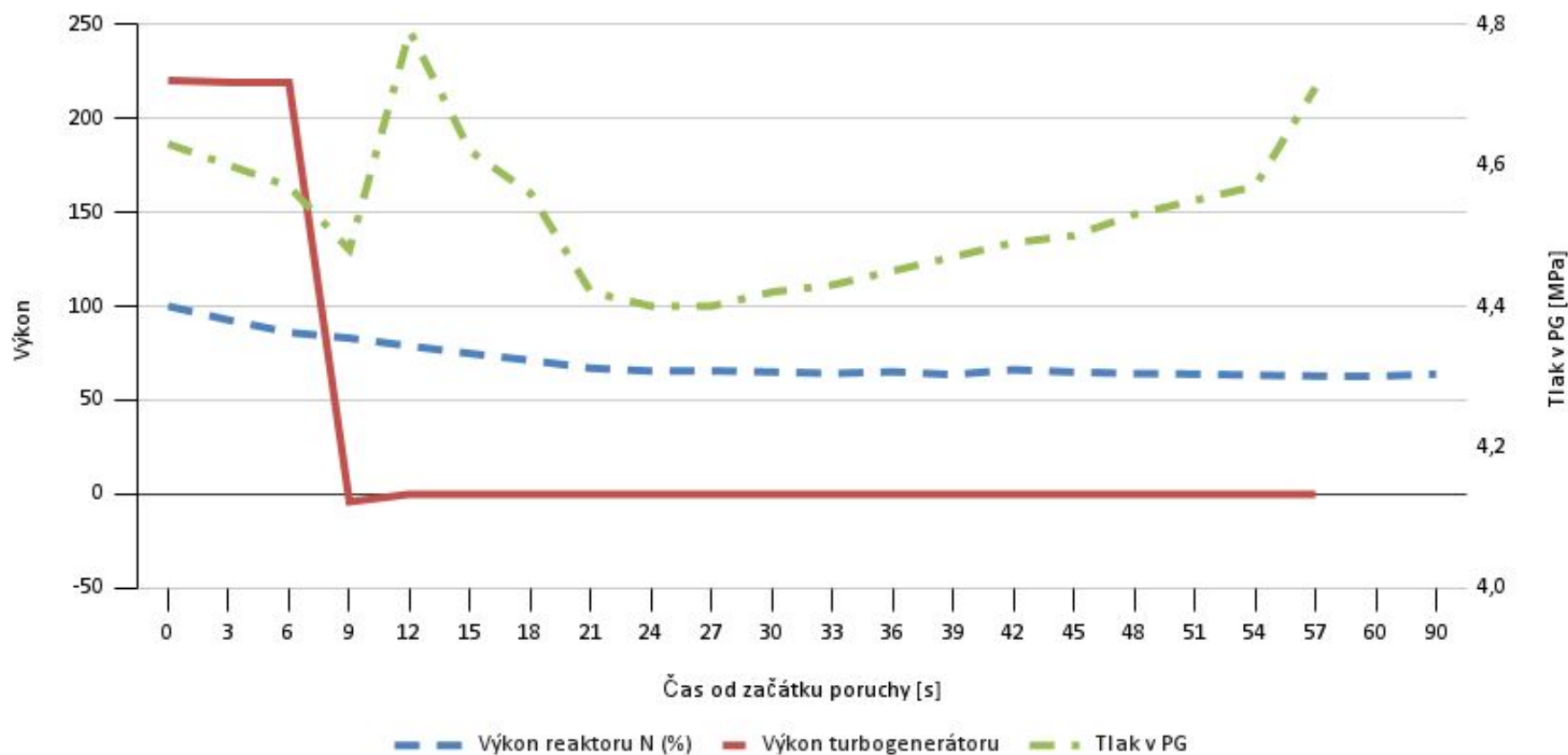

# Shrnutí

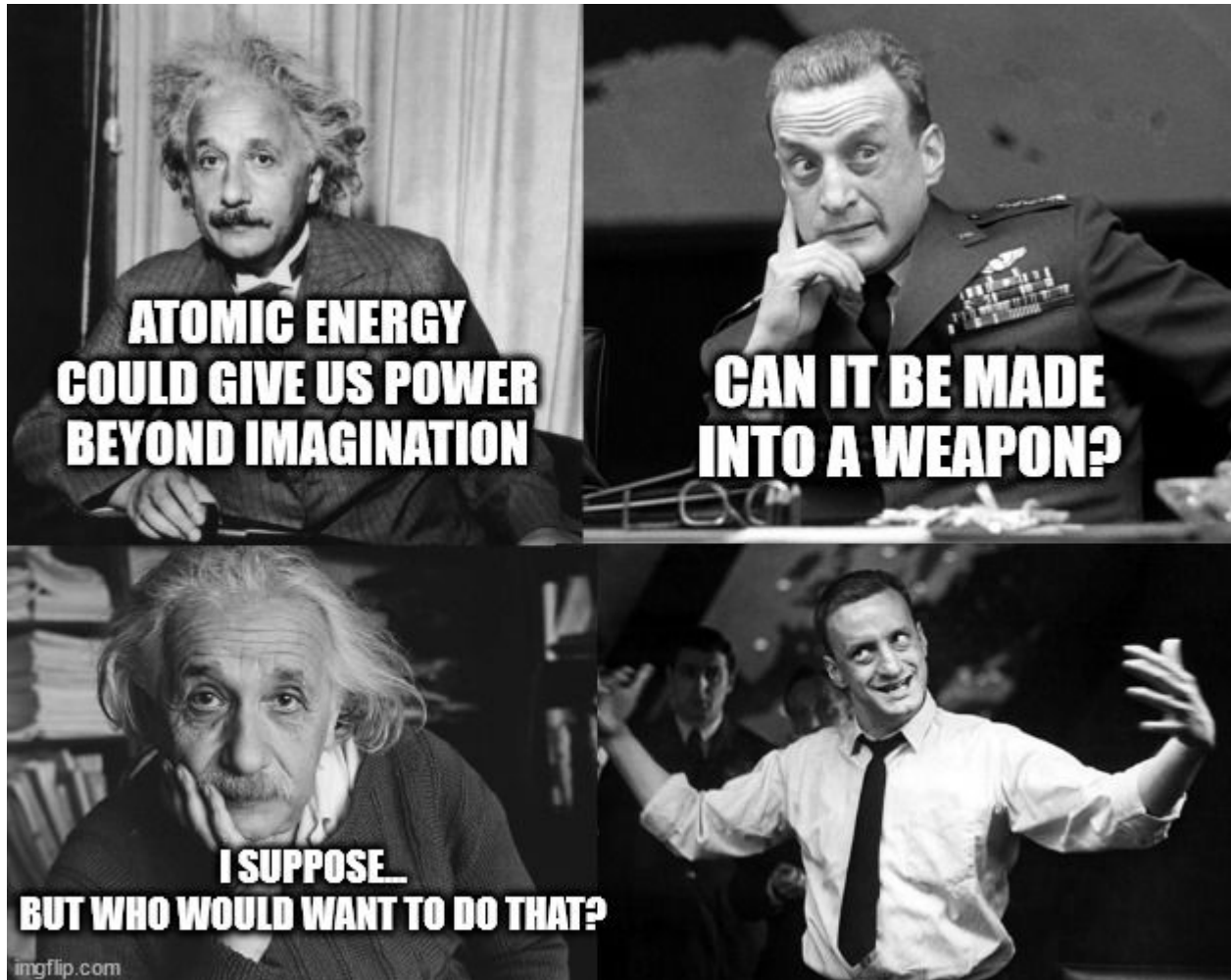

# Poděkování

- Pořadatelům TV na Jaderce
- Ing. Dušanu Kobylkovi, PhD.
- Posluchačům

**Děkujeme za pozornost**

---